

Contents

Contents	i
1 Introduction.....	1
1.1 Symbols.....	2
1.2 Warranty considerations.....	3
2 Description.....	4
2.1 General description.....	4
2.2 Features of Aeon7400A.....	4
2.3 Specification.....	5
3 Checking.....	6
3.1 Preoperative Checkout procedures.....	6
3.2 Testing the gas supply pipeline and the gas cylinder.....	8
3.3 Monitoring Flow Control.....	10
3.4 Installing and testing of vaporizer.....	14
3.5 Testing alarm.....	15
3.6 Testing the Breathing System.....	16
3.7 Testing Ventilator.....	17
4 Theory and Diagram.....	19
5 User Maintenance.....	21
5.1 Repair Policy.....	22
5.2 Maintaining Outline and Schedule.....	23
5.3 Replacing fuses.....	24

ELM-FAN.IR

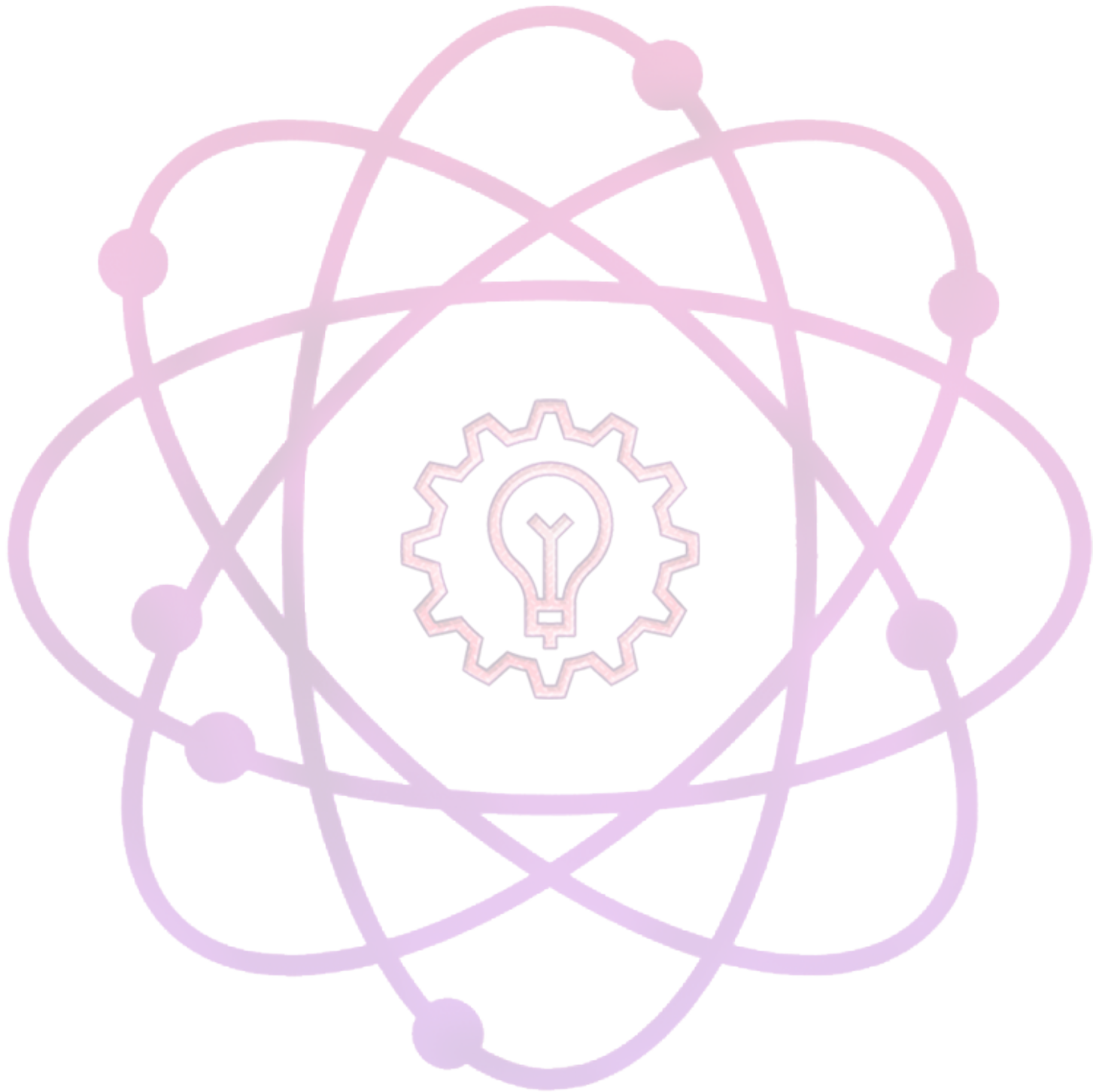

ELM-FAN.IR

1 Introduction

This service manual provides procedures for testing and maintaining the Aeonmed model anesthetic machine. It is not intended to be a complete maintenance document; therefore, it contains no disassembly or reassembly instructions.

Refer any repairs or adjustments that exceed the scope of this manual to the Service Center of Beijing Aeonmed Co., Ltd by calling

800-810-8333 or 86-10-88799987-333



This manual contains proprietary information. It is intended for use only by individuals qualified in the installation and maintenance of the Aeonmed anesthetic machine. Receipt, purchase, or possession of this document in no way confers or transfers any other rights for the use of this information. Disclosure or reproduction of the enclosed, without the written permission of Beijing Aeonmed Co., Ltd is prohibited.

This manual is intended for use only by technicians who have successfully completed Beijing Aeonmed Co., Ltd training on this product.

Beijing Aeonmed Co., Ltd believes the information herein is accurate but accepts no responsibility for errors, omissions, or misrepresentation.

ELM-FAN.IR

1.1 Symbols

 Warnings and  Cautions indicate all the possible dangers in case of violation of the stipulations in this manual. Refer to and follow them.

 **WARNING:** indicates potential hazards to operators or patients

 **CAUTION:** indicates potential damage to equipment

Instead of illustrations, other symbols may also be utilized. Not all of them may necessarily appear in the equipment and manual. The symbols include:

 ON (Power)

 OFF (Power)

 Alternating Current

 Protectively earth

 Equipotential

 Dangerous Voltage

 Movement in one direction

 Movement in two directions

 Inspiration flow

 Type B equipment

 SN Serial Number

 Warning or Caution, ISO 7000-0434

 NOTE: refer to the manual, IEC601-1

 This way up

 O₂+ Oxygen flush Button

 Lock

 Unlock

 Expiration flow

ELM-FAN.IR

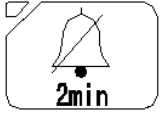

Alarm Silence



View the reading on the top of float



Ventilator operate



Bag operate

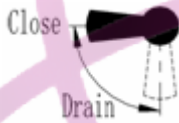

Directions of Drain Valve

1.2 Warranty considerations

Do not make any service repairs on this equipment during the states warranty period. Any unauthorized work immediately voids the warranty. Aeonmed will not be liable for any repairs attempted by the owner. Any such attempted repairs other than specified no warranty repairs void the warranty.

ELM-FAN.IR

2 Description

This chapter describes the systems, features, controls, and labels on the Aeonmed anesthetic machine. Also included is a description of the table of technical specifications.

2.1 General description

The **Aeon7400A** range of continuous flow inhalation anesthetic machines are intended for use with human patients, in conjunction with anesthetic vaporizers, breathing hoses and patient connection fittings which comply with the relevant ISO standard or equivalent.

Depending upon the patient circuit selected, the machines can be used in semi closed or closed circuit configurations.

Aeon7400A is applicable for patient of over 300mL with standard set and for child of over 80mL with bellows assembly and circles of child.

Aeon7400A equipped with MV200 microprocessor ventilator is pneumatic, electronic-controlled, pressure-limit and time-cycled ventilator with perfect IPPV ventilating mode and monitoring system.

2.2 Features of Aeon7400A

Feature	Aeon7400A
Model of ventilator	MV200
Mode of ventilation	IPPV/Manual
I:E ratio	2:1 to 1:4
Respiration frequency	6 to 60bpm
Tidal volume	0 to 1200ml
Power failure alarm	Yes
High pressure	20 to 60cmH ₂ O
Low pressure	5 to 20cmH ₂ O
Alarm silence	Not more than 120seconds
vaporizer	VP200
Circle absorber	Yes
Bellows	Adult/pediatric
Flowmeter	Four tubes, O ₂ /N ₂ O(cascade/continuous)

2.3 Specification

Power	
Power line	220V±22V, 50Hz±1Hz
Fuses	φ5×20, 0.5A (F)
	φ5×20, 5A (F)
	φ5×20, 2A (F)
Power usage	≤50W
Type	Positive pressure volume
Protection against electrical shock	Type of protection: class I
	Degree of protection: Type BF
Gas input	
Gas type	O ₂ /N ₂ O
Gas pressure	0.3-0.5Mpa
Environment	
Ambient temperature	+5 °C to +40°C
Relative humidity	Not more than 80%
Atmospheric pressure	96kPa to104kPa
Noise of whole set	<65dB(A)
Warming up	no less than 5min
Miscellaneous	
Dimensions	1350(H)×620(D)×650(W)mm
Work surface height	840mm
Writing tablet	540×300mm
Weight	120kg (265lb)

ELM-FAN.IR

3 Checking

3.1 Preoperative Checkout procedures

Test interval Preoperative Checkout should be done in the following situation:
Before the first patient's use everyday.
Before every patient's use.
Perform the programs according to requirements after repair or maintenance.

Test schedule is given in the table below:

Before use of the first patient each day

System check:
Power failure alarm test:
Gas pipeline and gas cylinder test:
Flow control test:
Vaporizer installation and test
Alarm test:
Breathing system test:
Ventilator test:

Before use of each patient

Breathing system test:
Ventilator test:

 **WARNING:** Do not use this system before the operation and maintenance manual are read and understood.

- Whole system connection
- All warnings and cautions
- Using guide of each system module
- Testing method of each system module

Before using this system:

- Complete all tests of this section
- Test all the rest of system modules

If test failure, do not use this system. Please contact service representative.

ELM-FAN.IR

3.1.1 System Checkout

⚠ WARNING: make sure the breathing circuit is connected correctly and in good condition.

Make sure:

- 1 Equipment is in good condition.
- 2 All the components are correctly connected.
- 3 Breathing circuit is correctly connected and in good condition; there is sufficient absorbent in the breathing system.
- 4 Vaporizer is in lock position and is filled with sufficient anesthetic.
- 5 The connection and pressure of pipeline gas supply system are correct.
- 6 The connected cylinder valve should be closed if there are backup cylinders.

⚠ WARNING: Do not leave the cylinder valves open during pipeline gas supply period; otherwise, cylinder gas supply will be used up and lead to insufficient supply in case of pipeline malfunction.

7. The required emergency device is ready and in good condition.
8. The device for airway maintenance, organ cannula are ready and in good condition.
9. The applicable anesthetic and emergency medicine are ready.
10. Make sure the truckles are tight and locked and free of motion.
11. Connect the power cord to the AC power outlet. The power indicator light will light up when power is connected.
If failure, that means no electric power supplying. Exchange other sockets, close breaker, or replace power cord.

3.1.2 Mains failure alarm test

- 1 Turn power switch to "I", stand-by interface appears after self-test.
- 2 After operating 5 minutes, pull out power cord.
- 3 Make sure that power off failure alarm occurs, it has the following characteristics:
 - Alarm sound;
- 4 Connect power cord again.
- 5 Make sure the alarm eliminate.

ELM-FAN.IR

3.2 Testing the gas supply pipeline and the gas cylinder

⚠ CAUTION: A user must confirm that gas supply is connected correctly; there is no any disconnection, leakage, faulty connection in gas circuits and pressure indicates correctly. Stop using and check gas connections if abnormal.

⚠ CAUTION: To prevent from damage:
Open cylinder valve slowly.
Never control the flow with excessive force.
Skip step 2 if the system is not using cylinder gas supply.

- 1 Disconnect all pipeline gas supply and close all the cylinder valves.
 - If the readings of the pipeline pressure gauge and cylinder pressure gauge are not zero.
 - Switch on O₂ supply.
 - Adjust flow control to middle range.
 - Make sure all the pressure gauges are reset to zero except the O₂ pressure gauge.
 - Switch off O₂ supply.
 - Make sure the O₂ pressure gauge is reset to zero. The low O₂ supply alarm should be on when pressure drops.
- 2 Make sure cylinders are fully filled:
 - Open each cylinder valve.
 - Make sure the pressure of each cylinder is high enough. In case the pressure is insufficient, close the corresponding cylinder valve and install a fully filled cylinder.
- 3 Test cylinder high pressure leak one by one.
- 4 Close flowmeters.
- 5 Open the cylinders.
- 6 Record the cylinder pressures.
- 7 Close the cylinder valves.

ELM-FAN.IR

- 8 Begin to record the pressures after one minute. If O₂ pressure drops to 5000 kPa, it means there is a leakage:
 - If leakage exists, according to direction of section 5.5, replace a new sheet gasket, and then tighten T handle.
 - Perform this step again. If leakage exists all the same, do not use this system.
- 9 Step 5 ~ 7 should be repeated for all the cylinders. N₂O pressure drop in one minute should not exceed 700 kPa.
- 10 Close all the cylinder valves.

⚠ CAUTION: Do not leave the cylinder valves open during pipeline gas supply period; otherwise, cylinder gas supply will be used up and lead to insufficient supply in case of pipeline malfunction.

- 11 Connect pipeline gas supply.
- 12 Check pipeline pressure according to the table below:

ANSI (U.S. and International), Australia, Canada, France and Japan	345 kPa (50 psig)
ISO, Italy, Scandinavia, South Africa, Spain and Switzerland	414 kPa (60 psig)
Austria and Germany	500 kPa (75 psig)

ELM-FAN.IR

3.3 Monitoring Flow Control

- ⚠ WARNING:** Refer to Step 1 to 13 of *monitoring without oxygen* for monitoring without oxygen.
Refer to Step 1 to 13 of *monitoring with oxygen* for monitoring with oxygen.

3.3.1 Monitoring without oxygen

- ⚠ WARNING:** The monitoring system cannot be replaced by link system. The fresh gas containing enough oxygen may not avoid the existence of low oxygen mixture in the breathing circuit.

If N₂O exists, it will pass through the system during the test, which should be securely collected and removed.

Patients may be injured by improper gas mixture. The link system should not be used if a proper ratio of O₂ and N₂O is not possible.

The following procedures can test whether the link system has serious malfunction; however, it cannot determine whether the calibration is correct.

- ⚠ CAUTION:** The gas flow switch should be adjusted slowly. Do not turn it hard when the reading of the flowmeter goes beyond the maximum or minimum flow rate; otherwise, the control valve can be damaged and the control will not work.

Follow the steps to test the flow control:

1. Connect the pipeline gas supply or open the cylinder valves slowly.
2. Turn clockwise all the flow control till the end (minimum flow).
3. Turn on mains switch.
4. Make sure:
 - The oxygen flow is between 25 mL/min and 75 mL/min.
 - No gas flowing in any other flow tube.
 - Step 5 and step 6 are only applicable for the N₂O system test.

⚠ WARNING: During Step 5 to Step 6, keep link systems working state.

Only adjust testing of control (N₂O in step 5 and O₂ in step 6).

Adjust flow according to order (N₂O firstly O₂ secondly).

If adjustable range exceeds, please adjust flow control to the nearest place and perform this step again.

5. To test the flow increase of the link system:

- Turn clockwise the N₂O and O₂ flow control till the end (minimum flow).
- Turn counterclockwise the N₂O flow control slowly.
- Set N₂O flow control to the rate described in the following table. The O₂ flow must be higher than the minimum flow limit.

Set N ₂ O flow to (liters per minute):	O ₂ flow must be higher than the minimum flow (liters per minute):
0.6	0.2
1.5	0.5
3	1.0
7.5	2.5

6. This step tests the function of the Link System when flow is reduced, you should:

Set N ₂ O flow to (liters per minute):	O ₂ flow must be higher than the minimum flow (liters per minute):
6.0	2.0
3.0	1.0
0.6	0.2

7. Adjust full flow of all the gas to ensure that the flowmeter float must move smoothly.

8. Shut off the oxygen supply either by closing the oxygen cylinder valve, or by disconnecting the oxygen pipeline supply.

9. Make sure:

- As pressure decreases, the oxygen-supply failure alarm must continuously sound.
- Disconnect the flow of nitrous oxide and oxygen to be sure that the oxygen flow will be the last to stop.
- If the oxygen is the driving gas of the ventilator, the oxygen-supply failure alarm must continuously sound.

10. Turn all of the flow control valve knobs completely clockwise to the minimum flow.

11. Reconnect oxygen pipeline supplies or slowly open the oxygen cylinder valve.

12. Turn off mains supply.

3.3.2 Monitoring with Oxygen

⚠ WARNING: The monitoring system cannot be replaced by link system. The fresh gas containing enough oxygen may not avoid the existence of low oxygen mixture in the breathing circuit.

If N_2O exists, it will pass through the system during the test, which should be securely collected and removed according to safe and eligible methods.

Patients may be injured by improper gas mixture. The link system should not be used if a proper ratio of O_2 and N_2O is not possible.

⚠ CAUTION: Before continuous testing, perform test of the O_2 monitoring device according to step 8 in section 3.6.

Follow the steps to test the flow control:

1. Connect the pipeline gas supplies, or slowly open the cylinder valve.
2. Turn all of the flow control valve knobs completely clockwise to the minimum flow.
3. Turn on mains switch.
4. Make sure:
 - The oxygen flow is between 25 mL/min and 75 mL/min.
 - No gas flowing in any other flow tube.
 - Step 5 and step 6 are only applicable for the N_2O system test.

⚠ WARNING: During Step 5 to Step 6, keep link systems working state.

Only adjust testing of control (N_2O in step 5 and O_2 in step 6).

Adjust flow according to order (N_2O firstly O_2 secondly).

The oxygen sensor being used must be calibrated correctly.

ELM-FAN.IR

- 5 To test the flow increase of the link system:
 - Turn clockwise the N₂O and O₂ flow control till the end (minimum flow).
 - Turn counterclockwise the N₂O flow control slowly.
 - Make sure that the oxygen flow is increasing. The concentration of the oxygen tested must $\geq 21\%$ during the complete process.
- 6 To test the flow increase of the link system:
 - Set the nitrous oxide flow to 9.0 L/min.
 - Set the oxygen flow to 3/min or higher.
 - Turn the flow control valve knob of the oxygen clockwise slowly.
 - Be sure that the oxygen flow is getting reduced. The concentration of the oxygen tested must $\geq 21\%$ during the complete process.
- 7 Adjust all of the gas full flow to ensure that the flowmeter floats must move smoothly.
- 8 Shut off the oxygen supply either by closing the oxygen cylinder valve, or by disconnecting the oxygen pipeline supply.
- 9 Make sure:
 - As pressure decreases, the oxygen-supply failure alarm must continuously sound.
 - Disconnect the flow of nitrous oxide and oxygen to be sure that the oxygen flow will be the last to stop.
 - If oxygen is the driving gas of the ventilator, the oxygen-supply failure alarm must continuously sound.
- 10 Turn all of the flow control valve knobs completely clockwise to the minimum flow.
- 11 Reconnect oxygen pipeline supplies or open the oxygen cylinder valve slowly.
- 12 Turn off mains supply.

ELM-FAN.IR

3.4 Installing and testing of vaporizer

3.4.1 Installation

- ⚠ WARNING:** Do not take the vaporizer away from the bypass valve with its locking lever locked.
- Do not use more than one vaporizer at the same time in this system.

Install vaporizers in accordance with the following steps:

1. The vaporizer must be disassembled and reinstalled if its top is not horizontal.
2. Set the locking lever of the vaporizer so that it is locked.
3. Try to lift the vaporizer directly upwards so as to separate itself from the bypass valve, but do not pull the vaporizer forwards. Be careful not to rotate it on the bypass valve.
4. As the vaporizer is taken away from the bypass valve, reinstall the vaporizer and then follow step 1 to step 3. Do not use this system if you cannot put return the vaporizer to a horizontal position on the bypass valve.
5. Try on opening two vaporizers at the same time.
 - Testing any possible instance of each combination.
 - If more than one vaporizer can be opened at the same time, disassemble and reinstall them, then perform step 1 to step 5.

3.4.2 Testing Vaporizer Back Pressure

- ⚠ CAUTION:** About performance testing of vaporizer refer to relevant instruction for use.

ELM-FAN.IR

3.5 Testing alarm

- 1 Connect reservoir bag to patient end.
- 2 Set bag/ventilator switch to ventilator control.
- 3 Turn on mains switch.
- 4 Set control options:

Ventilation mode:	IPPV mode
Ventilator:	V _T : 700ml f: 20bpm I:E: 1:2
Anesthetic machine:	O ₂ flow: minimum flow (25-75mL/min) All other gas: close Press O ₂ flush button to inflate bellows.

- 5 Set bag/ventilator switch to bag control, and then set to ventilator control again. Make sure:
 - Auto ventilation start.
 - Display right data on the screen.
 - Bellow assembly up and down during auto ventilation.
- 6 Adjust O₂ flow to 5L/min.
- 7 Make sure:
 - Pressure at the end of expiration is 0 cmH₂O approximately.
 - Right data displayed on the screen.
 - Bellow assembly up and down during auto ventilation.
- 8 Test high airway pressure alarm:
 - View airway pressure on the screen.
 - Adjust lower limit of Paw to above High Pressure, and conform the alarm occurs.
 - Adjust lower limit of Paw to below High Pressure, and conform the alarm eliminates.
- 9 Test low airway pressure alarm:
 - Remove reservoir bag form the absorber cycle.
 - Other alarm occurs, such as "Minute volume low".
 - Make sure that "Paw low" alarm occurs.
- 10 Turn off mains supply.

3.6 Testing the Breathing System

Refer to the operating manual and:

Verify the non-return valve in the Breathing circuit module works normally:

The non-return exhalation valve will ascend during the exhalation period while it will descend during the inhalation period.

⚠ WARNING: Objects in the breathing system can interrupt or disrupt the delivery of breathing system gas, resulting in possible patient death or injury:
Do not use any testing plug small enough to slip completely into the breathing system.

3.6.1 Checking Oxygen flush Switch

Press the oxygen flush button (the sound of gas should be heard from the fresh gas outlet) then release. The button must immediately drop back to its position and stop delivering the gas.

3.6.2 Testing Breathing System

Turn the switch of the anesthesia machine to Manual Bag. Pressure gauge is zeroed. APL Valve knob should be fully clockwise to the maximum. Connect the wye connector to the test lung.

Occlude the manual reservoir bag on the port below the switch. Press the oxygen flush button or open the flowmeter to make the indication of the pressure gauge achieve 3KPa, then release the button and close the flowmeter. After 20 seconds observation, the pressure indicated by the pressure gauge must not exceed 0.3KPa.

3.6.3 Testing APL Valve

Adjust the positions of every switch and knob according to the method of testing Breathing System Leak. Open the oxygen flow to 5 liters per minute. Adjust the APL valve to position the pressure of the pressure gauge in different places respectively. The common gas outlet must overflow some gas as the pressure is stable.

⚠ WARNING: Be sure that there is no any testing plug or foreign objects in the Breathing System.

3.7 Testing Ventilator

- 1 Connect the test lung to the patient circuit port.
- 2 Set the Reservoir bag / Ventilator switch to the Reservoir bag position.
- 3 Turn on mains switch.
- 4 Set control options:

Ventilation mode:	IPPV mode
Ventilator:	V _T : 700ml f: 20bpm I:E: 1:2
Anesthetic machine:	O ₂ flow: less than 200mL All other gas: close Press O ₂ flush to charge bellows.

- 5 Set the bag / Ventilator switch to ventilator control.
- 6 Press the Oxygen flush button to inflate the bellows.
- 7 Ensure:
 - Auto ventilation start.
 - No low pressure alarm.
 - Ventilator displays the correct data.
 - The bellows ascend and descend during the period of auto ventilation
- 8 Set the O₂ flow control to 5L/min.
- 9 Ensure:
 - Ending expiratory pressure is about 0 cmH₂O.
 - Ventilator displays the correct data.
 - The bellows inflate and scavenge during the period of auto ventilation.
- 10 Set the ventilator control and alarm limits to the proper clinical level.
- 11 Turn off mains supply and close all valves of gas cylinders if not to use the system.

ELM-FAN.IR

12 Ensure that the things in the following table should be prepared completely.

Apparatus:	Airway maintenance Manual ventilation Organ cannula
anesthesia and emergent drugs applicably	

13 System preparation:

- Close all vaporizers.
- Open the APL valve.
- Set the bag / ventilator switch to bag control.
- Set all the flow controls to the minimum.
- Be sure that the breathing system connects correctly

⚠ WARNING: Be sure that the breathing system connects correctly.

⚠ WARNING: Flush the anesthesia machine for at least one minute by using O₂ with 5L/min flow speed to remove unnecessary mixed gas and objects in the system before connecting the equipment to the patient end.

⚠ WARNING: Anesthesia equipment must be connected to the waste gas scavenging system to outlet the waste gas to prevent the staff working in the operating rooms from injury.

This requirement must be followed in the testing and clinical application.

ELM-FAN.IR

4 Theory and Diagram

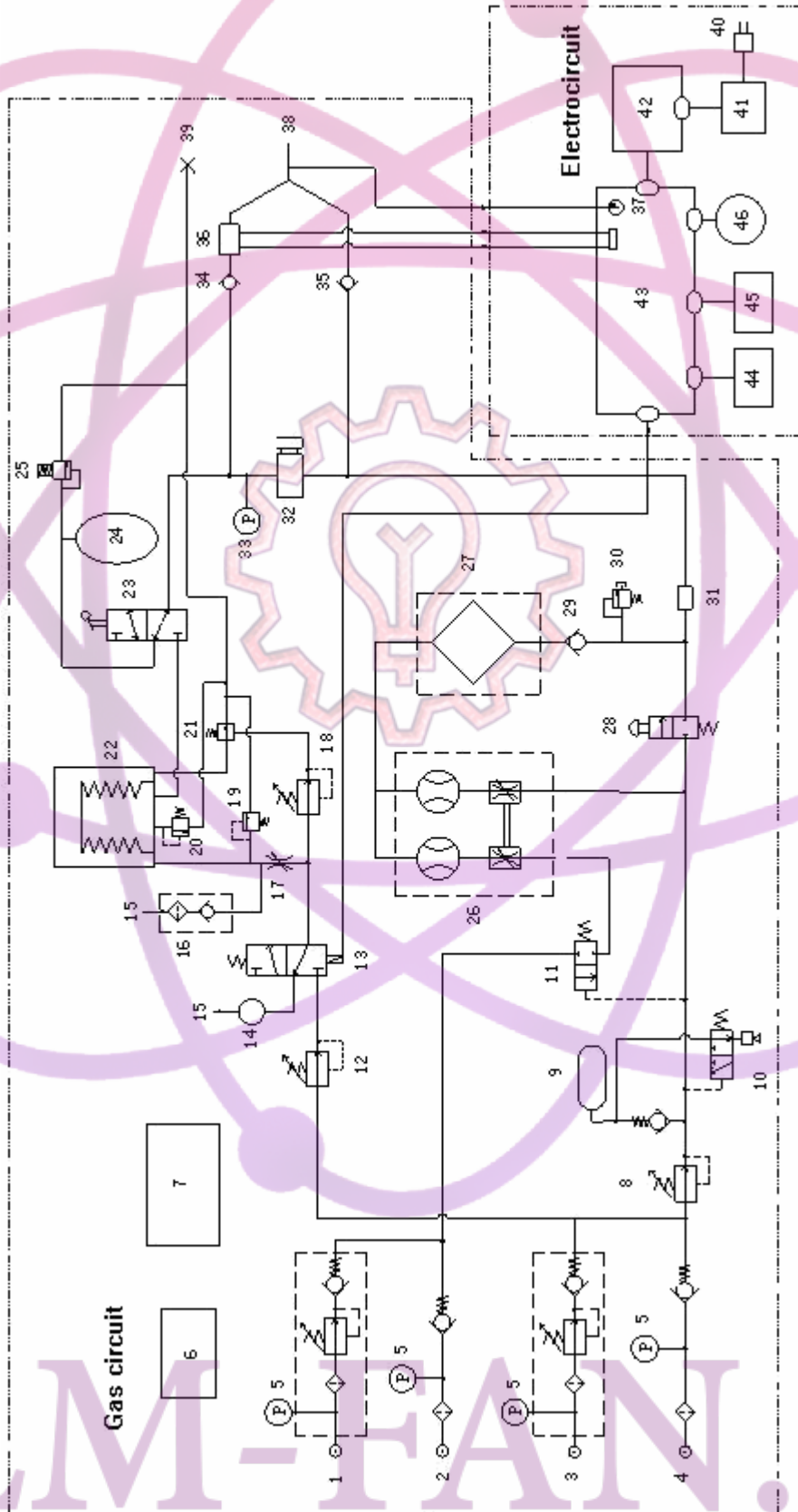

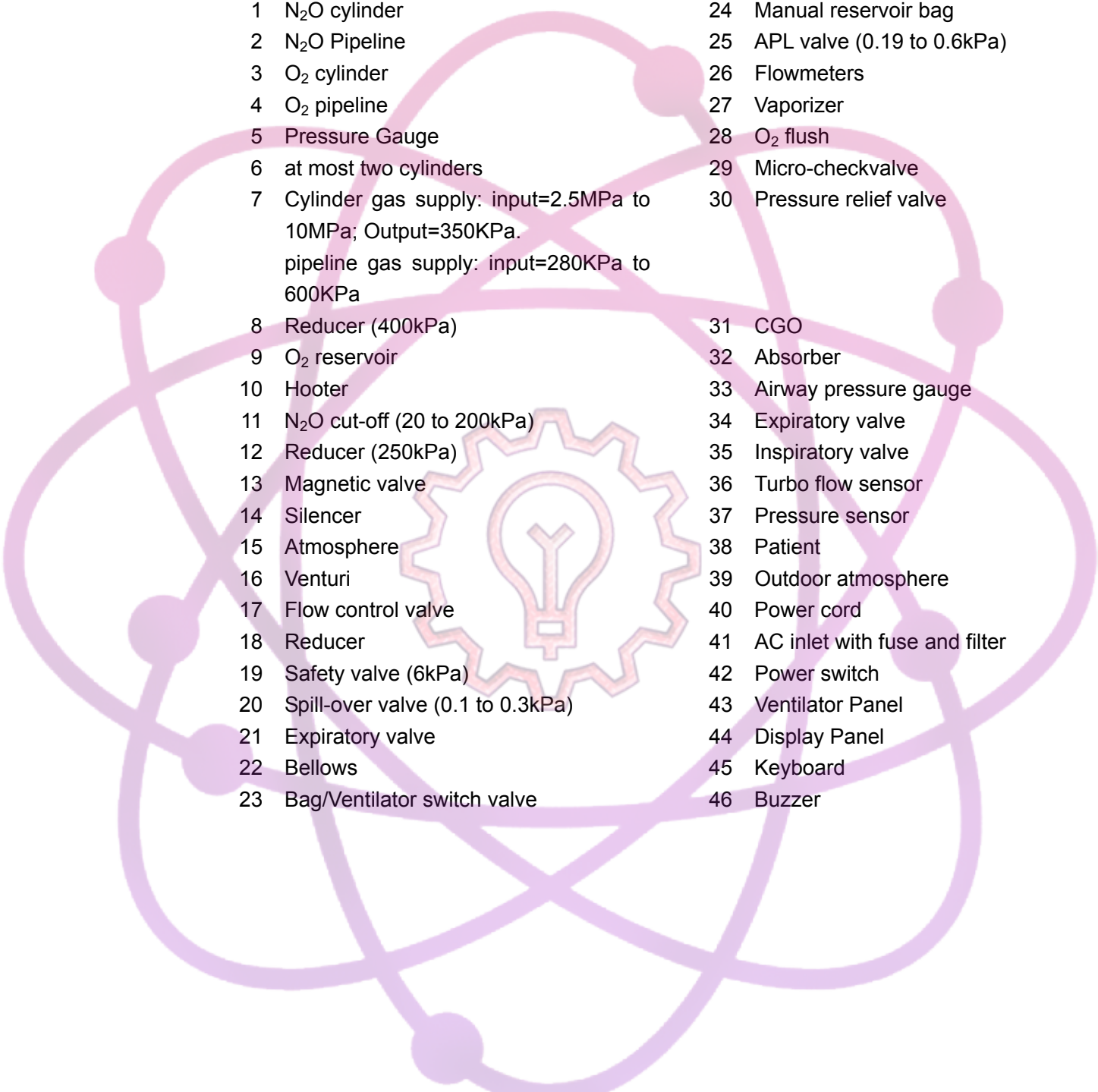
- 
- 1 N₂O cylinder
 - 2 N₂O Pipeline
 - 3 O₂ cylinder
 - 4 O₂ pipeline
 - 5 Pressure Gauge
 - 6 at most two cylinders
 - 7 Cylinder gas supply: input=2.5MPa to 10MPa; Output=350KPa.
pipeline gas supply: input=280KPa to 600KPa
 - 8 Reducer (400kPa)
 - 9 O₂ reservoir
 - 10 Hooter
 - 11 N₂O cut-off (20 to 200kPa)
 - 12 Reducer (250kPa)
 - 13 Magnetic valve
 - 14 Silencer
 - 15 Atmosphere
 - 16 Venturi
 - 17 Flow control valve
 - 18 Reducer
 - 19 Safety valve (6kPa)
 - 20 Spill-over valve (0.1 to 0.3kPa)
 - 21 Expiratory valve
 - 22 Bellows
 - 23 Bag/Ventilator switch valve
 - 24 Manual reservoir bag
 - 25 APL valve (0.19 to 0.6kPa)
 - 26 Flowmeters
 - 27 Vaporizer
 - 28 O₂ flush
 - 29 Micro-checkvalve
 - 30 Pressure relief valve
 - 31 CGO
 - 32 Absorber
 - 33 Airway pressure gauge
 - 34 Expiratory valve
 - 35 Inspiratory valve
 - 36 Turbo flow sensor
 - 37 Pressure sensor
 - 38 Patient
 - 39 Outdoor atmosphere
 - 40 Power cord
 - 41 AC inlet with fuse and filter
 - 42 Power switch
 - 43 Ventilator Panel
 - 44 Display Panel
 - 45 Keyboard
 - 46 Buzzer

ELM-FAN.IR

5 User Maintenance

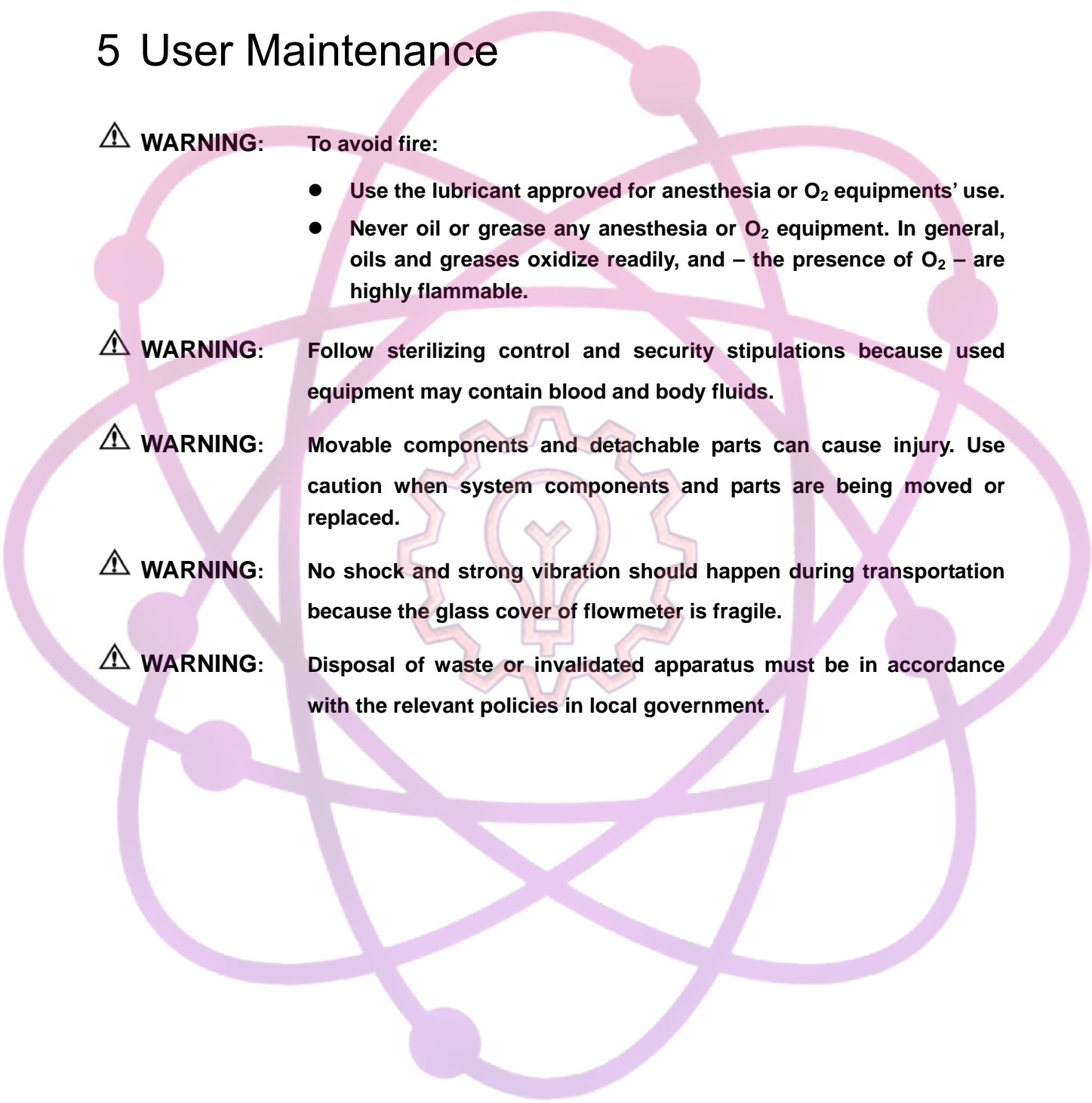
- 
- ⚠ WARNING:** To avoid fire:
- Use the lubricant approved for anesthesia or O₂ equipments' use.
 - Never oil or grease any anesthesia or O₂ equipment. In general, oils and greases oxidize readily, and – the presence of O₂ – are highly flammable.
- ⚠ WARNING:** Follow sterilizing control and security stipulations because used equipment may contain blood and body fluids.
- ⚠ WARNING:** Movable components and detachable parts can cause injury. Use caution when system components and parts are being moved or replaced.
- ⚠ WARNING:** No shock and strong vibration should happen during transportation because the glass cover of flowmeter is fragile.
- ⚠ WARNING:** Disposal of waste or invalidated apparatus must be in accordance with the relevant policies in local government.

ELM-FAN.IR

5.1 Repair Policy

Do not use malfunctioning equipment. Make all necessary repairs, or have the equipment serviced by an authorized Aeonmed Service Representative. After repair, test the equipment to ensure that it is functioning properly, in accordance with the manufacturer's published specifications.

To ensure full reliability, have all repairs and service done by an authorized Aeonmed Representative. If this is not possible, replacement and maintenance of parts in this manual should be performed by a competent, trained individual with experience in Anesthesia Systems repair, and appropriate testing and calibration equipment.

⚠ CAUTION: No repair should ever be undertaken or attempted by anyone without proper qualifications and equipment.

It is recommended that you replace damaged parts with components manufactured or sold by Aeonmed. After any repair work, test the unit to ensure it complies with the manufacturer's published specifications.

Contact the nearest Aeonmed Service Center for service assistance. In all cases, other than where Aeonmed's warranty is applicable, repairs will be made at Aeonmed's current list price for the replacement part(s) plus a reasonable labor charge.

ELM-FAN.IR

5.2 Maintaining Outline and Schedule

The following schedule is a recommended minimum standard based upon normal usage and environmental conditions. Frequency of maintenance for the equipment should be higher if your actual schedule is more than the minimum standard.

5.2.1 User maintenance

Minimum Standard	maintaining	Planned maintaining Standard
Daily		Clean the outer surface.
weekly		Ventilate the system, open flowmeter, and make sure that the float move up and down smoothly. It can prevent blocking and clinging.
monthly		Test leakage of bellows assembly. (refer to User Manual)
When cleaning and installing		Check if any components are broken, and replace or repair them if necessary.
As required		Replace new gasket of cylinder gas supply. Perform flow sensor calibration when flow waveform is unusual. Open the drain valve and replace absorbent in the absorber.

5.2.2 Permissive Repairing

Minimum Standard	maintaining	Planned maintaining Standard
6 months		Test electric current leakage.
6 months		Test mechanical safety valve.
12 months		Perform the maintenance, checking, testing, calibrating and replacing of the components stipulated in this manual by qualified individuals.

Notes: This is the recommended minimum maintaining level. Perform the local policies if they are equal to or higher than those in this manual.

5.3 Replacing fuses

- ⚠ WARNING:** Disconnect from power supply before replacing fuses, otherwise that can injure operator even death.
- ⚠ WARNING:** Replace fuses with only those of the specified type and current rating, otherwise that can damage the equipment.
- ⚠ CAUTION:** The fuse is fragile, so replacement should be carefully. Do not use excessive force.

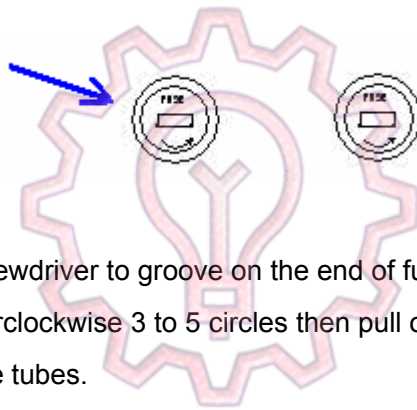

Replacing steps:

- 1 Plug the screwdriver to groove on the end of fuse box.
- 2 Turn counterclockwise 3 to 5 circles then pull out fuse tubes lightly.
- 3 Take off fuse tubes.
- 4 Enclose the new ones.
- 5 Push fuse tubes to original place gently.
- 6 Turn clockwise 3 to 5 circles with screwdriver to tighten.
- 7 Connect mains supply.

ELM-FAN.IR